

Hydraulic Breaker



Hydraulic Breaker

HYDRAULIC BREAKERS



Fx - SERIES
 F6, F9 - SERIES
 XP - SERIES

FRD FURUKAWA ROCK DRILL CO.,LTD.

5-3, 1-chome, Nihonbashi, Chuo-ku, Tokyo 103-0027, Japan
 Phone +81-3-3231-6982 Fax +81-3-3231-6994
 URL: www.furukawarockdrill.co.jp/en/



Yoshii works and Takasaki works have been ISO9001, ISO14001 certified.



F-series-E1211-F4
 Printed in Japan

FRD FURUKAWA ROCK DRILL

<http://linespareparts.com>



Furukawa built breakers develop remarkable power, designed for world advanced hydraulic excavators.

- 1. Increased reliability and durability !*
- 2. Higher blow-breaking power !*
- 3. Reduced maintenance cost !*
- 4. Expanded multifunctional capabilities !*
- 5. Innovative design !*
- 6. New developed NT-BOX !*

WHY FRD HYDRAULIC BREAKERS?

Today Furukawa Rock Drill is a worldwide specialist in demolition and rock excavation with a wide range of carefully designed and robust breakers, attachments and crawler drills. Since its founding in 1875 Furukawa Rock Drill has specialized in the demolition and rock excavation. Their over hundred thirty years experience has assured the company of an excellent reputation. All products are manufactured in the company's own plants using only the best materials under the highest quality control.

LOWEST LIFETIME COST

FRD breakers have been designed to be durable, reliable, simple, and low maintenance: with superior performance adapted to conditions; easy, reliable operation and lowest lifetime cost. The result of decades of dedication. And synonym for easiest on-site operations, maximum operator peace of mind and optimal contributor to shareholder value. The purchasing department will appreciate the message.

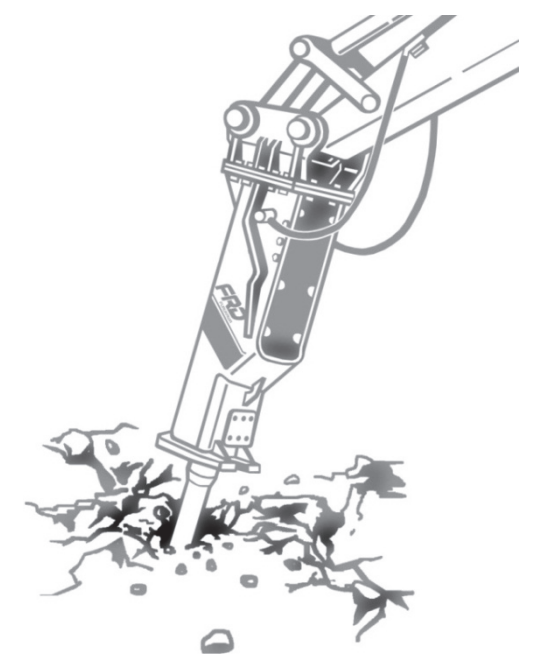



SMALL HYDRAULIC BREAKERS

Hydraulic + gas operating system

Fx series model could tremendously reduce the new breakers noise levels.

1. Mono-block cylinder
2. Without through bolt
3. Cylinder liner
4. Easy replaceable wear parts

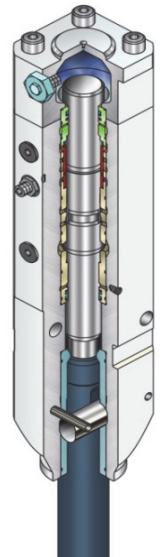

- ▶ Square body design for superior strength.
- ▶ Easy access gas charged back head.
- ▶ Mono-block design eliminates a separate cylinder, front head & through-bolts.
- ▶ Replaceable cylinder liner.
- ▶ Large diameter piston.
- ▶ Field replaceable front bushing.

Body durability increased and maintenance cost is reduced by using combined cylinder both piston action part and rod seating part, and without through bolt. Expanded oil pressure and oil flow range make it possible to be suits wider range of small size excavator. Using valve adjuster, it is possible to adjust oil pressure and gas pressure for back head to match excavator.

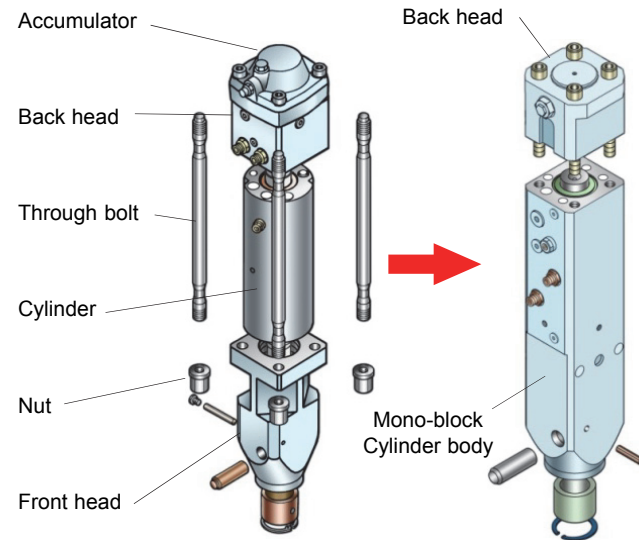

Conventional model

Back head, Cylinder and Front head are chained by through bolt.

Fx series

Combined cylinder body by adoption of cylinder liner, and through bolt less body reduce maintenance cost.

ST-Box housing is the extreme silent form in relation with new developed breaker body. The fully closed frame with sound proofing kit gives a considerable reduction in sound levels and vibration.

In cooperation with the Technical University of Tokyo, FRD could tremendously reduce the new breakers noise levels. A complete new development of impact mechanism minimizes the discharge of vibration to the excavator, as well reduces the operators vibration stress dramatically. Because of FRD optimized the applied materials with a new hardness process, a higher efficiency at same operation weight is guaranteed.

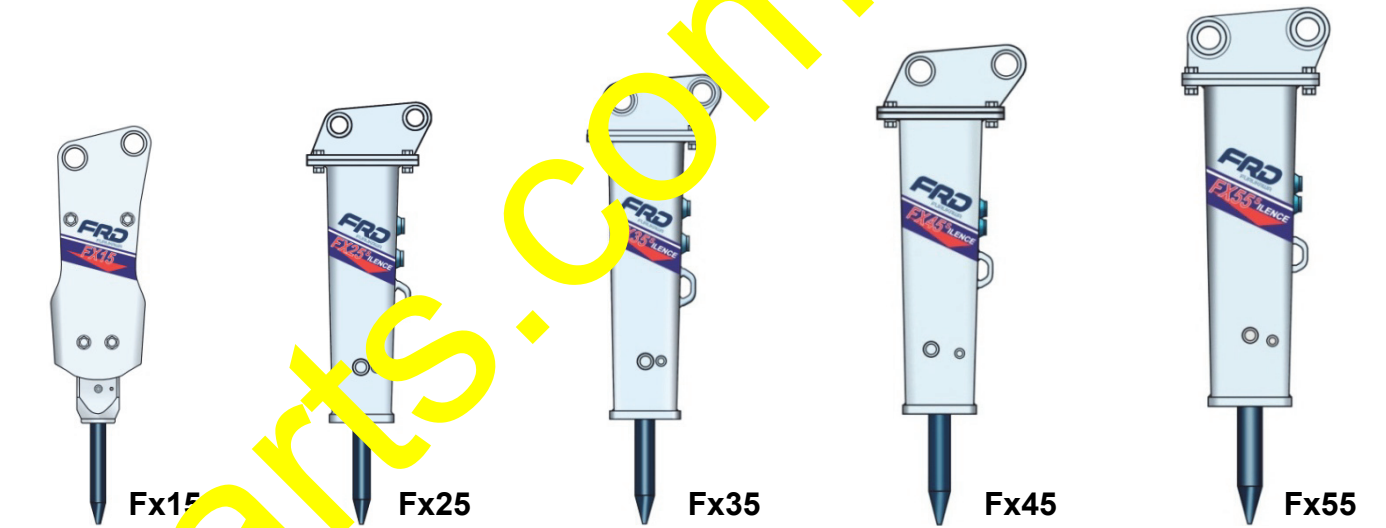
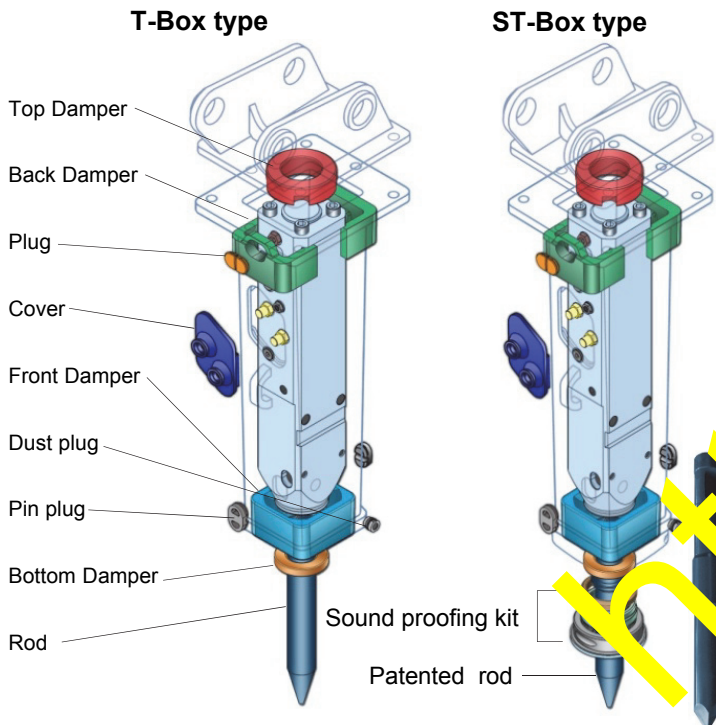

Model		Fx15	Fx25	Fx35	Fx45	Fx55
Body weight (incl. head)	kg	36	56	80	110	150
Operating weight						
Side plate	kg	60	83	129	165	220
T-Box incl. Top bracket	kg	-	112	157	208	280
ST-Box incl. Top bracket	kg	-	118	167	220	292
Height						
Side plate	mm	924	1,030	1,172	1,285	1,388
T-Box incl. Top bracket	mm	-	1,097	1,209	1,342	1,440
Width						
Side plate	mm	180	180	214	214	235
T-Box incl. Top bracket	mm	-	180	214	235	235
Back head sealed gas pressure	MPa	0.7	0.7	0.9	0.9	0.9
Impact rate	min ⁻¹	600 - 1,500	600 - 1,500	600 - 1,300	600 - 1,100	500 - 1,100
Oil flow rate	L/min	10 - 22	18 - 32	24 - 42	30 - 56	40 - 72
Operating oil pressure	MPa	10 - 14	10 - 14	12 - 16	12 - 16	12 - 16
Rod diameter	mm	36	45	52	60	68
Hose diameter	mm	9	12	12	12	12
Weight of base machine	ton	0.85 - 1.5	1.35 - 2.5	1.9 - 3.5	3.0 - 4.5	4.0 - 5.5

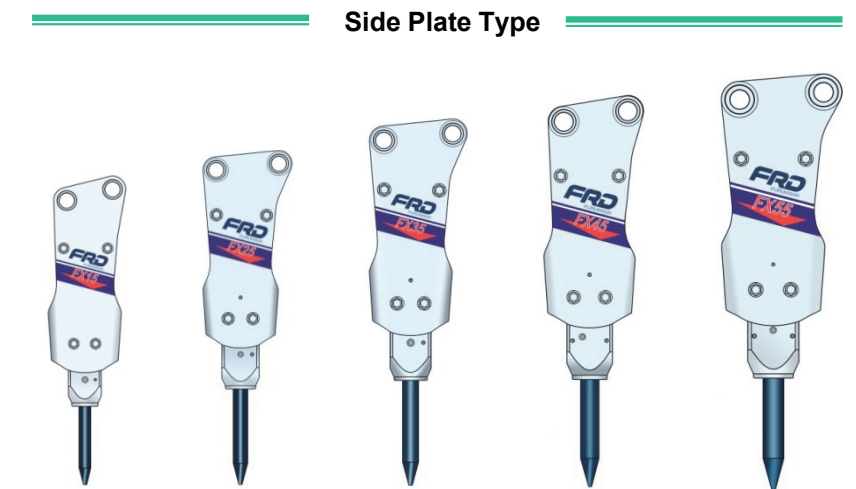



MEDIUM HYDRAULIC BREAKERS

Hydraulic + gas operating system

F series models responding to next generation needs by offering new functions and greater versatility.

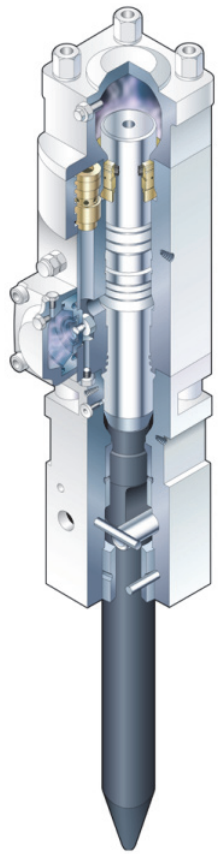

- ▶ Large diameter through bolts with "CD" threads.
- ▶ Nitrogen charged back head.
- ▶ Side mount nitrogen charged accumulator.
- ▶ Shuttle valve.
- ▶ Large diameter piston.
- ▶ Replaceable thrust bushing.
- ▶ Two retaining pins for greater alignment with rod.
- ▶ Replaceable front head bushing.

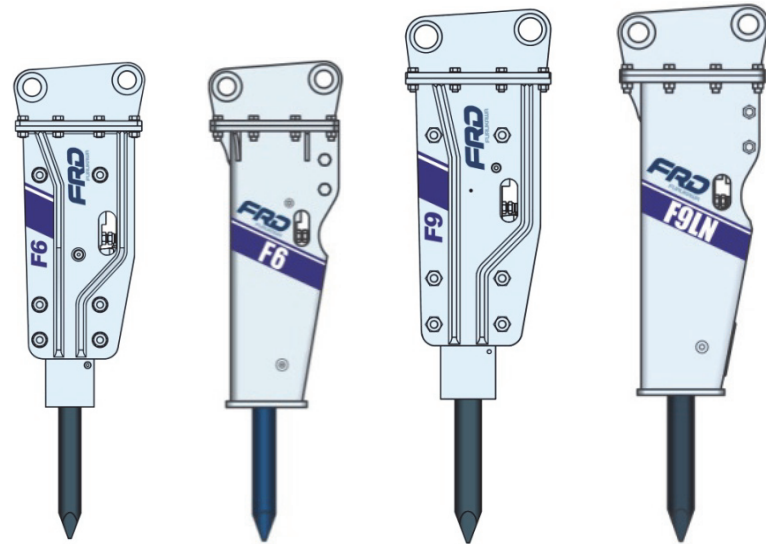

F6

F9

Model		F6	F9
Body weight (incl. Rod)	kg	195	300
Operating weight			
Side plate	kg	320	480
*T-Box incl. Top bracket	kg	350	535
Height			
Side plate	mm	1,630	1,877
*T-Box incl. Top bracket	mm	1,617	1,835
Width			
Side plate	mm	260	320
*T-Box excl. Top bracket	mm	260	210
Back head sealed gas pressure	MPa	6	10.9
Impact rate	min ⁻¹	65 - 100	550 - 900
Oil flow rate	L/min	50 - 90	65 - 115
Operating oil pressure	MPa	10 - 15	12 - 15
Rod diameter	mm	75	90
Hose diameter	mm	19	19
Weight of base machine	ton	5.5 - 6.5	6.5 - 9.0

- Increase in back head pressure and large piston diameter results in 25% greater impact energy.
- Longer thrust bushing improves piston alignment during impact and incorporates grease holes to evenly distribute grease in the front head.
- Large diameter piston for increase in impact energy.
- Increased front head wall thickness for added service life.

F6 & F9 Backhoe Loader Version

F6 & F9 "BHL Version" features custom built side plates that are provided with different pin locations by manufacturer. Backhoe arm and breaker can be folded up within the machine width for on road travel. Custom designed offset hinge pin position increases working clearance. Elevated support pin of bucket cylinder position ensures strong hold down of the breaker.



LARGE HYDRAULIC BREAKERS

Hydraulic + gas operating system

Advanced Technology Supporting New Functions



- ▶ Large diameter through bolts with "CD" threads.
- ▶ Patented dust intake prevention system.
- ▶ Nitrogen charged back head.
- ▶ Side mount nitrogen charged accumulator.
- ▶ Innovative valve housing.
- ▶ Large diameter piston.
- ▶ Replaceable thrust bushing.
- ▶ Two reversible retaining pins for maximum contact with rod.
- ▶ Replaceable front cover.

Control Valve

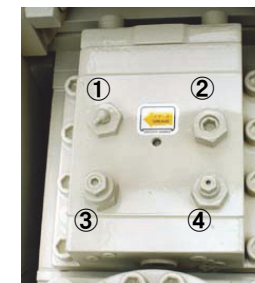

- ① Grease application port
- ② Valve adjuster
- ③ Stroke adjuster (manual)
- ④ Safety valve

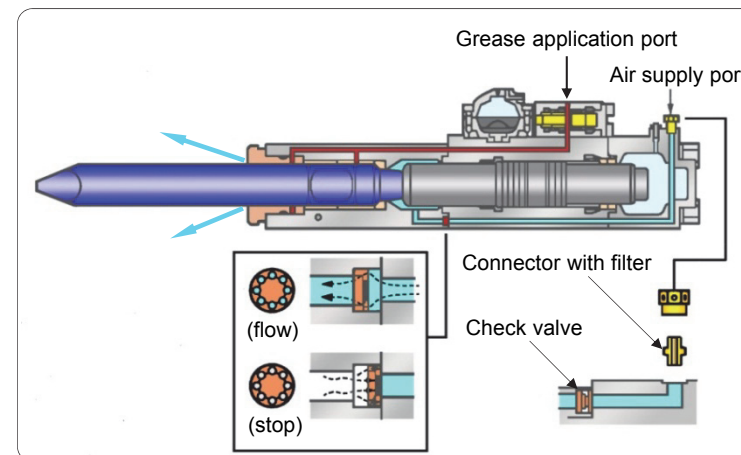

Piston idle blow prevention function Optional

During a long stroke, at the instant that the object to be crushed has been broken, idle blow of the piston normally occurs, but with the F-series, it is automatically eliminated.

Number-of-blows manual adjustment function Standard

Stepless adjustment is possible via the adjuster. Further, spool replacement allow selection of "idle blow" and "idle blow prevention" during a long stroke. ("idle blow prevention" type fitted as standard)

Number-of blows remote adjustment function Optional

Thanks to installation of pilot pressure piping operator manipulation from within the cabin permits on/off selection as switching between low/high number-of-blows.

Safety valve function Standard

Should the operating pressure rise above 21-22MPa, the "safety valve" incorporated in the hydraulic breaker automatically opens to protect the breaker from an overload.

"Auto-grease" function Optional

Standard internal piping allows direct grease application to the front cover and the thrust-bush section, thereby improving rod and bush life. Further, detachment of the grease nipple and installation of dedicated piping, enables an automatic grease supply by remote control, either from within the cabin or with a timer system, to be used.

Dust intake prevention function Standard

A specially incorporated device prevents dust (such as rock dust) from being drawn into the "Front head". Incorporation of an "Air filter" and "Air check valve" in the back head and front head, eliminates the "air pump phenomenon" caused by the piston's in/out movements, thus creating an automatic dust prevention effect.

Tunnel/underwater functional compatibility Optional

When the air and grease piping are added to the dust intake and auto greasing functions, tunnel as well as underwater operations can also be realized.



LARGE HYDRAULIC BREAKERS

Hydraulic + gas operating system

Behind their simple exterior FRD breakers hide many years' of experience, careful learning and intelligent design. There are hundreds of reasons to let FRD products do your work, here are just some of them.

1. High Power / Weight Ratio
2. Minimum Moving Parts
3. Adjustable Valve
4. High Reliability
5. Low Maintenance
6. Lowest Lifetime Cost

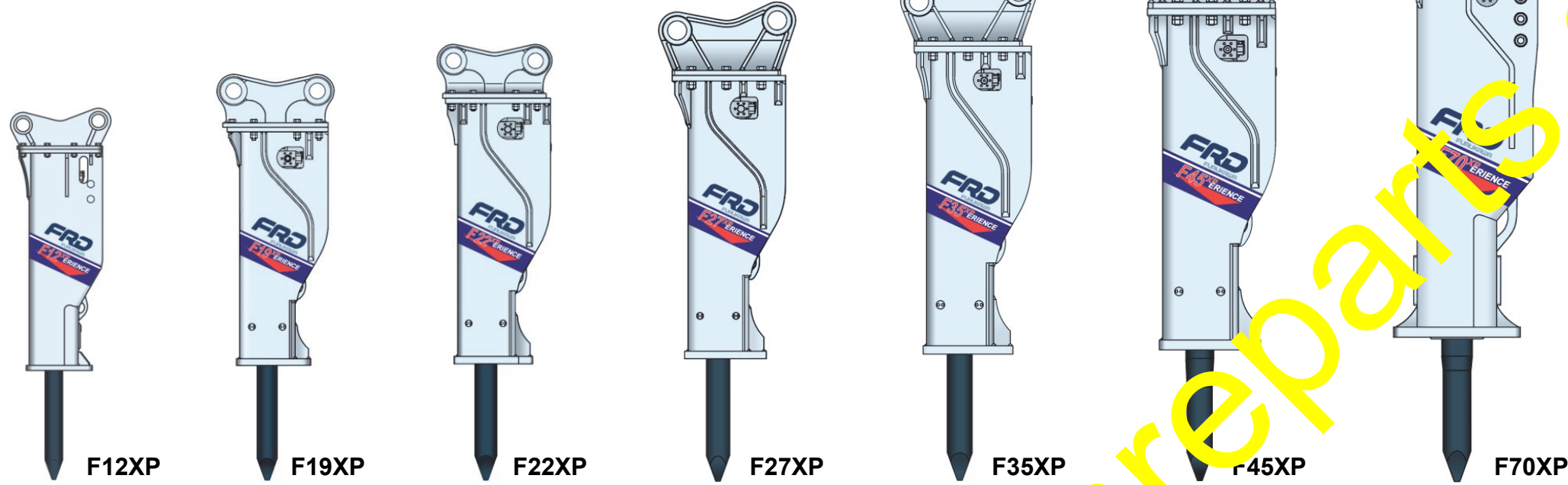

Model		F12XP	F19XP	F22XP	F27XP	F35XP	F45XP	F70XP
Body weight (incl. Rod)	kg	500	640	865	960	1,210	1,590	2,250
Operating weight								
Side plate	kg	830	1,180	1,565	1,930	2,255	2,965	-
*T / NT-Box incl. Top bracket	kg	860	1,290	1,640	1,860	2,365	3,000	4,310
Height								
Side plate	mm	2,229	2,498	2,683	2,875	3,090	3,270	-
*T / NT-Box incl. Top bracket	mm	2,214	2,441	2,661	2,875	3,057	3,250	3,810
Width								
Side plate	mm	391	500	500	600	600	600	-
*T / NT-Box excl. Top bracket	mm	391	500	500	600	600	600	760
Back head sealed gas pressure (at 10°C)	MPa	0.9	0.9	0.9	0.9	0.9	0.9	0.9
Impact rate	min ⁻¹	450 - 625	400 - 525	320 - 460	340 - 440	320 - 400	300 - 350	250 - 320
Oil flow rate	L/min	100 - 130	120 - 150	145 - 180	155 - 190	175 - 220	200 - 250	250 - 340
Operating oil pressure	MPa	16 - 18	16 - 18	16 - 18	16 - 18	16 - 18	16 - 18	16 - 18
Rod diameter	mm	105	120	135	140	150	165	180
Hose diameter	mm	19	25	25	25	25	32	32
Weight of base machine	ton	9.0 - 14	14 - 19	19 - 22	22 - 26	26 - 32	32 - 44	44 - 70
Standard feature								
Piston idle blow enabling function		○	○	○	○	○	○	○
High pressure protector function		○	○	○	○	○	○	—
Manual stroke adjustment function		○	○	○	○	○	○	○
Two-way back head		—	○	○	○	○	○	○
Dust intake prevention function		○	○	○	○	○	○	○
Optional feature								
Piston idle blow prevention function		○	○	○	○	○	○	—
Remote control stroke adjustment function		○	○	○	○	○	○	—
IN/OUT swivel adaptor		—	○	○	○	○	○	○
**Tunneling specifications		○	○	○	○	○	○	○
**Underwater specifications		○	○	○	○	○	○	○

Remarks * Mark is shown as T-BOX for F12 & F70, NT-Box for F19 - F45
 ** Marks are special applications, please consult with FURUKAWA or FURUKAWA authorized Distributor.

New XPerience

NT-BOX Frame Type



As usual FRD has designed its new XPerience line to offer the benefits of minimum maintenance needs and a maximum of user convenience and output assurance. Large noise reductions of some 6dbA has been achieved against past models. Reduced vibration effects likewise make the models more friendly for users and the immediate user environment. Modern design and new colors complements a carefully thought through physical structure.

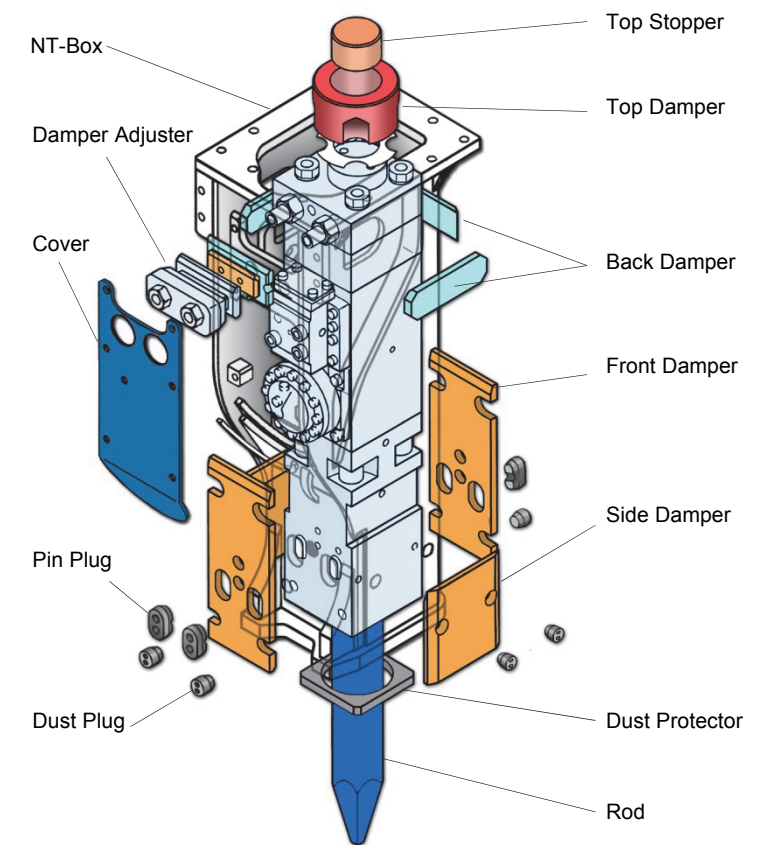

ST-Box is the extreme silent frame. In relation with new developed breaker body, the fully closed frame with sound proofing kit gives a considerable reduction in sound levels and vibration. Because of FRD optimized the applied materials with new hardness process, a higher efficiency at same operation weight is guaranteed.

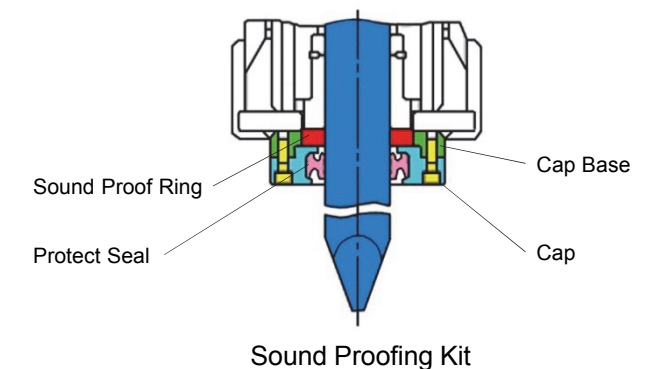

Bracket Variation

Side Plate Type

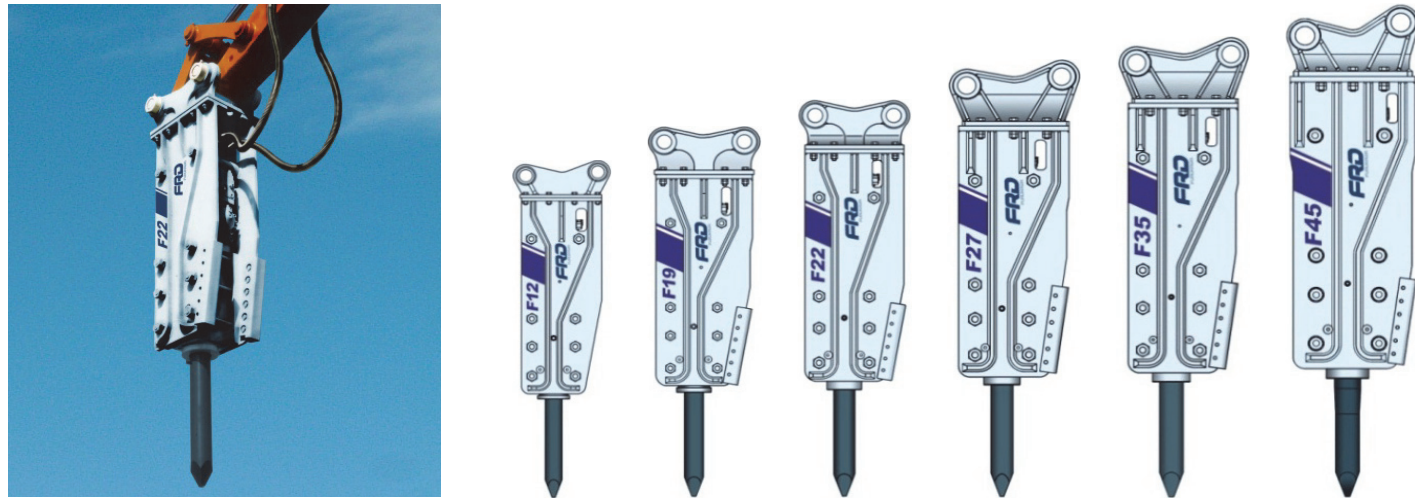

Set Plate Type



F series

Silent Box Type (Side Bracket)



F series

Fx series

Types of rods

Selecting an appropriate rod is required according to the nature of work and the characteristics of the object to break.

Use : FURUKAWA Genuine ROD

Moil point



Multipurpose applications, including breaking of extra hard rock, hard rock, hard stone, and reinforced concrete, as well as excavation of bedrock.

Flat rod



Secondary breaking in quarries, boulder breaking, concrete breaking, and slab breaking.

Wedge point

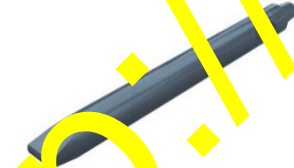

Concrete breaking, excavation of bedrock, operations on the face of slope, excavation of trenches, etc.

Ball point rod

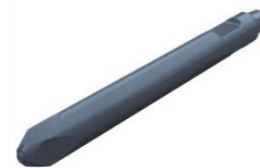

Breaking metal ores, as well as quartzite and other highly abrasive objects.

Special application

Tunnel Breaker

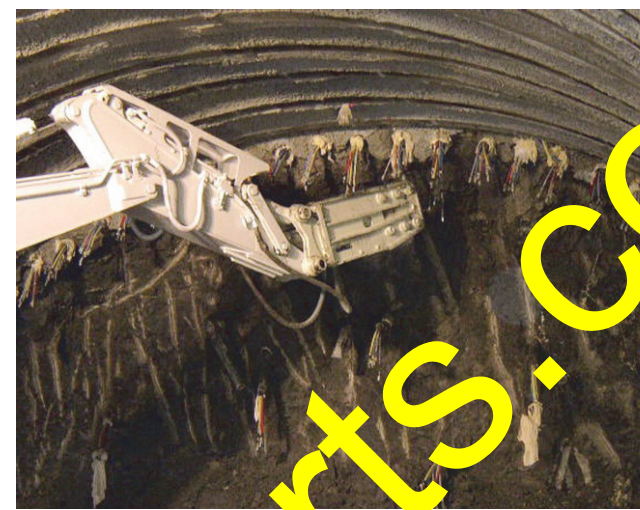

The following functions are added to enable the breaker to be more durable even under the harsher operating conditions peculiar to tunneling:

1. The NT-BOX type frame has been designed to especially realize sound suppression and vibration isolation, as well as extended durability.
2. Air compressor piping design prevents water/dust/earth/sand from entering the breaker main unit.
3. Auto grease piping automatically delivers lubrication to the front section, thus helping to further improve durability of the front section.

*Prepare an air compressor.



Underwater Breaker



A simplified, easily maintained (as compared with conventional models) air compressor piping connection port that attaches to the breaker main unit is provided at the upper section of the back head. Also, a check valve (inside the breaker main unit) acts to effectively externally discharge air, thus preventing entrance of water, dust, earth and sand.

*Prepare an air compressor.



Heat-resistant Breaker



Pedestal System

